









Welcome to Grindex Pump handbook!

With this handbook we want to share some of our wide experience in pumping with submersible pumps. You will find an overview of all Grindex pumps with technical details and a pump school, intended to help pump users with common matters in pumping with submersible pumps. The handbook also contains more sophisticated technical information, like pH tables and graphs that show friction losses in pipes and hoses.

We are sure you will find this handbook handy. This handbook is also available for download from our website, www.grindex.com.

If you need more copies, please contact a Grindex representative near you.

INDEX

	Drainage pumps	4-23
	Micro, Milli, Mini, Minex, Minette, Minor, Major, Master, Matador, Maxi, Magnum & Mega	
	Sludge pumps	24-31
	Solid, Salvador, Senior & Sandy	
	Drainage pumps made of stainless steel, INOX	32-39
	Minette Inox, Major Inox, Master Inox & Mega Inox	
	Sludge pumps made of stainless steel, INOX	40-45
	Salvador Inox, Senior Inox & Sandy Inox	
	Slurry pumps	46-57
	Bravo 200, 300, 400, 500, 600, 700, 800 & 900	
	Primo pumps	58-63
	Primo D4, D8, S4 & S8	
	Accessories	64-65
	Grindex Pump School	66-71
	Limitations	72
	More technical information	73-76
	Calculating friction losses in hoses	73
	Formulas for calculating friction losses in hoses and tubes	74
	Friction factor	74
	Sludge/slurry solids concentration	74
	pH tables	75
	Salt tables	75
	Translation charts	76
	Recommended generator sizes	77-78
	Torque values	79

Drainage pumps

Grindex drainage pumps are designed for professional use in tough applications like mines, construction sites, tunnel sites and other demanding industries.

They are designed for:

- Pumping water that may contain solids
– up to the size of the strainer holes
- Pumping water with abrasive solids
- Pumping ground water
- Pumping raw water
- Pumping spillage water

Grindex drainage pumps are designed for continuous, unattended operation. They have proven their reliability and dependable performance in demanding areas like building and construction, mining, tunnelling, quarries, industries and rental applications.



This page is a "target image" for the "Grindex Cutaway"-app with 3D and Augmented Reality functions

FEATURES

Drainage Pumps

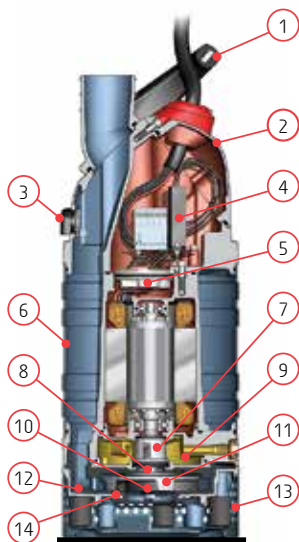

1. Ergonomic handle with a rubber grip on a metal frame
2. Inspection cover with large opening for easy access to junction box
3. Air valve cools the pump when no water is pumped
4. SMART motor protection including phase-failure guard, temperature guard and phase-sequence control eliminating the need for external start box
5. Enhanced terminal board with quick release terminal plate and sealing function
6. Durable outer jacket made from corrugated stainless steel
7. Easy service cartridge seal in rugged metal housing for improved heat transfer and longer pump life
8. Built-in particle repeller carries particles away from the seal for increased pump life
9. Simplified oil inspection and service, thanks to external plugs
10. Single adjustment screw for easy adjustment of the impeller and better performance
11. Hard-Iron™ impeller for maximum durability and performance
12. Heavy-duty polyurethane coating (optional for drainage pumps)
13. Durable strainer in stainless steel with ergonomic grip
14. Wear Protection system for increased life of hydraulic parts

MICRO

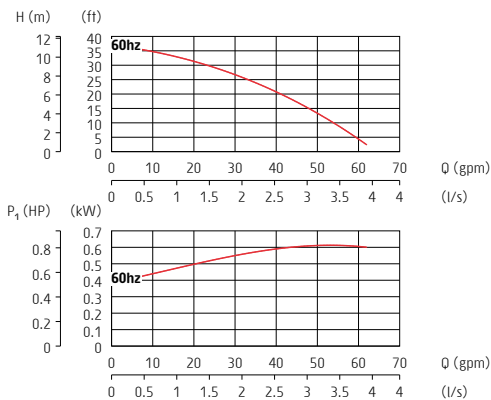

Technical Data 60 Hz

Micro

Pump type	8121.211
Discharge connection	2"
Rated power P ₂	0.56 Hp (0.42 kW)
Max. power cons. P ₁	0.87 kW
Shaft speed	3300 RPM
Rated current at 115V	5.5 A
Rated current at 230V	2.9 A
Solids passage	0.4x0.2" (11x5 mm)
Max. height	17.25" (440 mm)
Max. width	7.25" (185 mm)
Weight	26.5 lbs (12 kg)

For further information, see data sheets. Specifications can be changed without notice.

MILLI

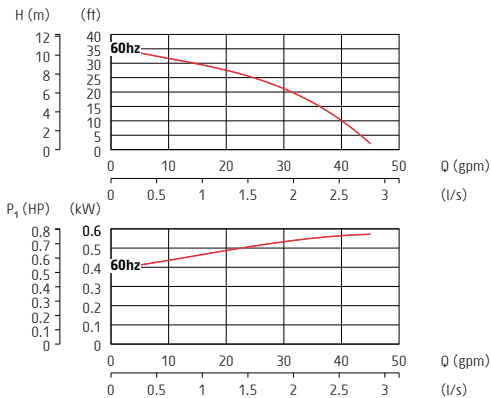

Technical Data 60 Hz

Milli

Pump type	8125.230
Discharge connection	2"
Rated power P ₂	0.6 HP (0.45 kW)
Max. power cons. P ₁	0.65 kW
Shaft speed	3300 RPM
Rated current at 115V	5.5 A
Rated current at 230V	2.9 A
Solids passage	0.25" (6.2 mm)
Max. height	18.25" (464 mm)
Max. width	7.4" (188 mm)
Weight	28.7 lbs (13 kg)

For further information, see data sheets. Specifications can be changed without notice.

MINI

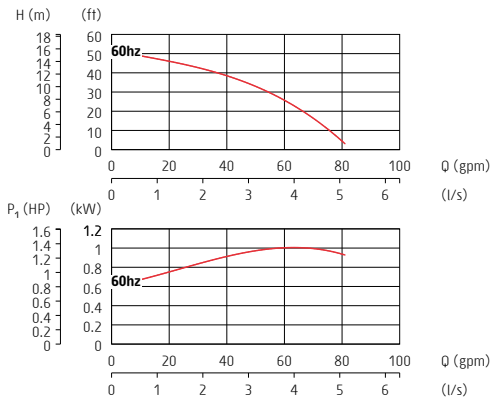

Technical Data 60 Hz

Mini

Pump type	8122.211
Discharge connection	2"
Rated power P ₂	1.1 HP (0.82 kW)
Max. power cons. P ₁	1.1 kW
Shaft speed	3400 RPM
Rated current at 115V	9.8 A
Rated current at 230V	4.8 A
Solids passage	0.4x0.2" (11x5 mm)
Max. height	17.3" (440 mm)
Max. width	7.3" (185 mm)
Weight	32 lbs (14.5 kg)

For further information, see data sheets. Specifications can be changed without notice.

MINEX LITE

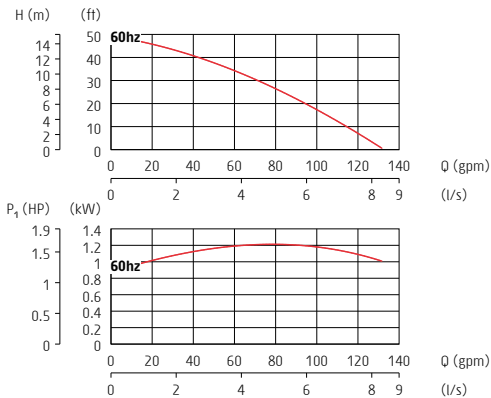

Technical Data 60 Hz

Minex Lite 1-ph

Pump type	8101.172
Discharge connection	2"
Rated power P ₂	1.3 HP (0.97 kW)
Max. power cons. P ₁	1.3 kW
Shaft speed	3410 RPM
Rated current at 115V	11 A
Rated current at 230V	5.6 A
Solids passage	0.3" (7.5 mm)
Max. height	24.25" (616 mm)
Max. width	7.9" (200 mm)
Weight	47.5 lbs (21.5 kg)

For further information, see data sheets. Specifications can be changed without notice.

MINEX

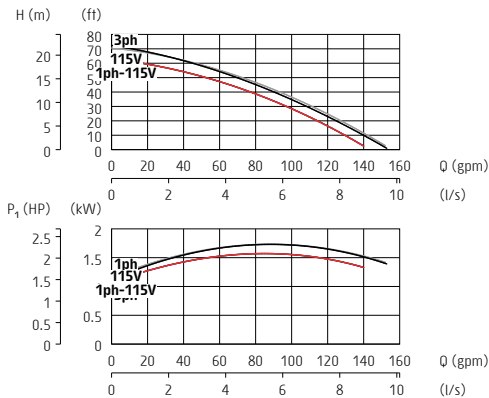

Technical Data 60 Hz	Minex 1-ph 115V	Minex 1-ph 230V	Minex 3-ph
Pump type	8101.160	8101.160	8101.172
Discharge connection	2"	2"	2"
Rated power P ₂	1.8 HP (1.3 kW)	2.0 HP (1.5 kW)	1.9 HP (1.4 kW)
Max. power cons. P ₁	1.7 kW	1.8 kW	1.8 kW
Shaft speed	3415 RPM	3460 RPM	3355 RPM
Rated current at 115V	15A	-	-
Rated current at 230V	-	8.2 A	5.2 A
Rated current at 460V	-	-	2.6 A *
Rated current at 575V	-	-	2.1 A *
Solids passage	0.3" (7.5 mm)	0.3" (7.5 mm)	0.3" (7.5 mm)
Max. height	24.3" (616 mm)	25.5" (646 mm)	24.3" (616 mm)
Max. width	7.9" (200 mm)	7.9" (200 mm)	7.9" (200 mm)
Weight	47.5 lbs (21.5 kg)	55 lbs (25 kg)	47.5 lbs (21.5 kg)

* Also available in MSHA-approved design (curves and ratings may differ from above) - US only.
For further information, see data sheets. Specifications can be changed without notice.

MINETTE

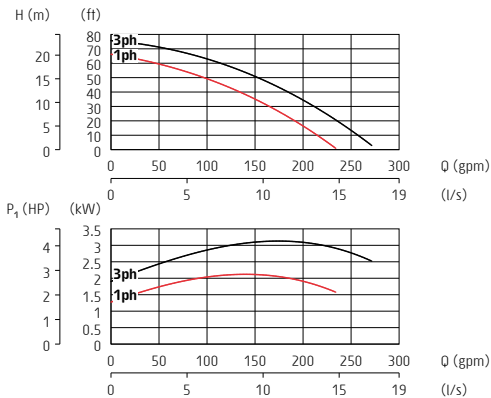

Technical Data 60 Hz

Minette 1-ph

Minette 3-ph

Pump type	8102.172	8102.172
Discharge connection	3"	3"
Rated power P ₂	2.4 HP (1.8 kW)	3.5 HP (2.6 kW)
Max. power cons. P ₁	2.2 kW	3.1 kW
Shaft speed	3405 RPM	3410 RPM
Rated current at 230V	9.9 A	9.5 A
Rated current at 460V	-	4.7 A *
Rated current at 575V	-	3.5 A *
Solids passage	0.35" (9 mm)	0.35" (9 mm)
Max. height	26.5" (676 mm)	26.5" (676 mm)
Max. width	9.5" (240 mm)	9.5" (240 mm)
Weight	64 lbs (29 kg)	64 lbs (29 kg)

* Also available in MSHA-approved design (curves and ratings may differ from above) - US only.
For further information, see data sheets. Specifications can be changed without notice.

MINOR

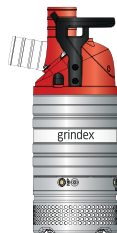
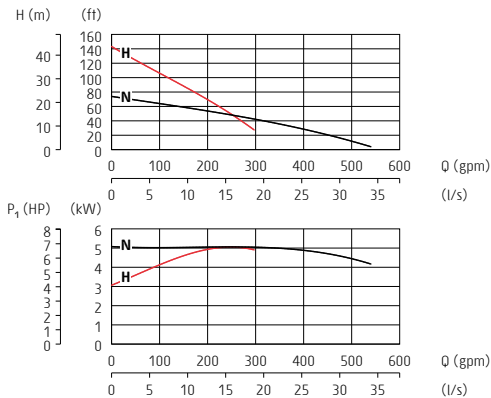

Technical Data 60 Hz

	Minor N	Minor H
Pump type	8103.181	8103.181
Discharge connection	4"	3"
Rated power P ₂	6.0 HP (4.4 kW)	6.0 HP (4.4 kW)
Max. power cons. P ₁	5.2 kW	5.2 kW
Shaft speed	3480 RPM	3480 RPM
Rated current at 230V	15 A	15 A
Rated current at 460V	7.1 A *	7.1 A *
Rated current at 575V	5.5 A *	5.5 A *
Solids passage	0.4" (10 mm)	0.4" (10 mm)
Max. height	30.2" (768 mm)	30.2" (768 mm)
Max. width	11.3" (286 mm)	11.3" (286 mm)
Weight	110 lbs (50 kg)	110 lbs (50 kg)

* Also available in MSHA-approved design (curves and ratings may differ from above) - US only.
For further information, see data sheets. Specifications can be changed without notice.

MAJOR

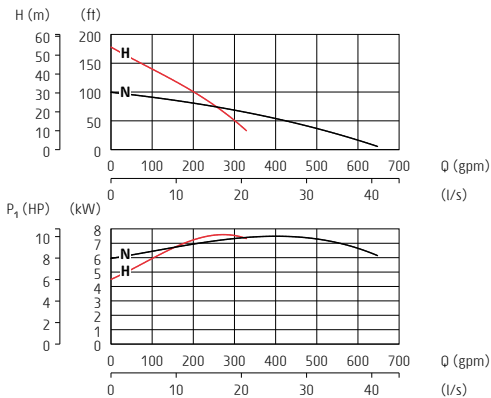

Technical Data 60 Hz

	Major N	Major H
Pump type	8104.181	8104.181
Discharge connection	4"	3"
Rated power P ₂	9.0 HP (6.6 kW)	9.0 HP (6.6 kW)
Max. power cons. P ₁	7.7 kW	7.7 kW
Shaft speed	3470 RPM	3470 RPM
Rated current at 230V	22 A	22 A
Rated current at 460V	11 A *	11 A *
Rated current at 575V	8.7 A *	8.7 A *
Solids passage	0.4" (10 mm)	0.4" (10 mm)
Max. height	30.2" (768 mm)	30.2" (768 mm)
Max. width	11.3" (286 mm)	11.3" (286 mm)
Weight	110 lbs (50 kg)	110 lbs (50 kg)

* Also available in MSHA-approved design (curves and ratings may differ from above) - US only.
For further information, see data sheets. Specifications can be changed without notice.

MASTER

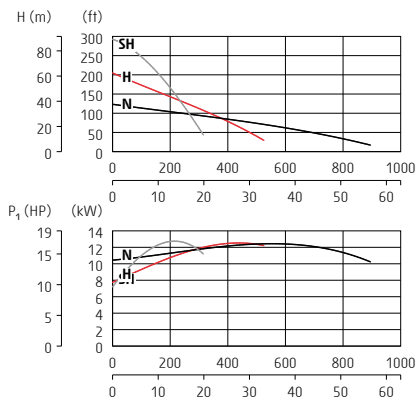

Technical Data 60 Hz

	Master N	Master H	Master SH
Pump type	8105.182	8105.182	8105.182
Discharge connection	6"	4"	3"
Rated power P ₂	15 HP (11.2 kW)	15 HP (11.2 kW)	15 HP (11.2 kW)
Max. power cons. P ₁	12.8 kW	12.8 kW	12.8 kW
Shaft speed	3465 RPM	3465 RPM	3465 RPM
Rated current at 230V	35 A	35 A	35 A
Rated current at 460V	18 A *	18 A *	18 A *
Rated current at 575V	14 A *	14 A *	14 A *
Solids passage	0.4" (10 mm)	0.4" (10 mm)	0.4" (10 mm)
Max. height	32.8" (832 mm)	32.8" (832 mm)	35" (887 mm)
Max. width	13.7" (346 mm)	13.7" (346 mm)	13.7" (346 mm)
Weight	176 lbs (80 kg)	176 lbs (80 kg)	216 lbs (98 kg)

* Also available in MSHA-approved design (curves and ratings may differ from above) - US only.
For further information, see data sheets. Specifications can be changed without notice.

MATADOR

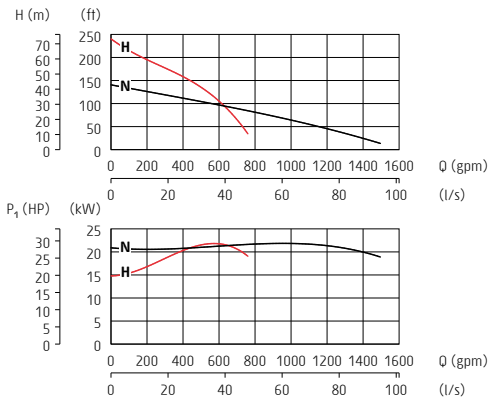

Technical Data 60 Hz

	Matador N	Matador H
Pump type	8106.181	8106.181
Discharge connection	6"	4"
Rated power P ₂	27 HP (20 kW)	27 HP (20 kW)
Max. power cons. P ₁	22 kW	22 kW
Shaft speed	3495 RPM	3495 RPM
Rated current at 230V	61 A	61 A
Rated current at 460V	31 A *	31 A *
Rated current at 575V	25 A *	25 A *
Solids passage	0.5" (12 mm)	0.5" (12 mm)
Max. height	37.6" (954 mm)	37.6" (954 mm)
Max. width	15.6" (395 mm)	15.6" (395 mm)
Weight	289 (131 kg)	289 (131 kg)

* Also available in MSHA-approved design (curves and ratings may differ from above) - US only.
For further information, see data sheets. Specifications can be changed without notice.

MAXI H LITE

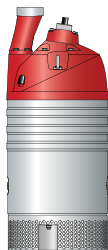
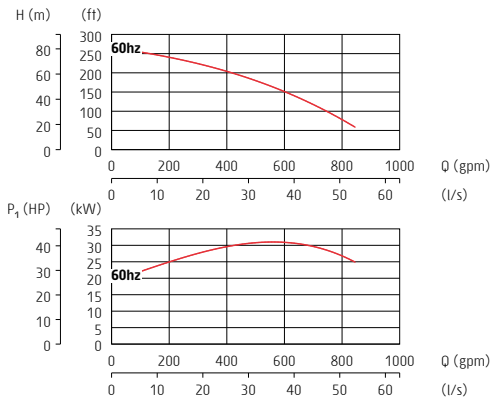

Technical Data 60 Hz

Maxi H Lite

Pump type	8107.300
Discharge connection	4"
Rated power P ₂	39 HP (29 kW)
Max. power cons. P ₁	32 kW
Shaft speed	3505 RPM
Rated current at 230V	87A
Rated current at 460V	44 A
Rated current at 575V	35 A
Solids passage	0.5" (12 mm)
Max. height	41" (1046 mm)
Max. width	17" (436 mm)
Weight	463 lbs (210 kg)

For further information, see data sheets. Specifications can be changed without notice.

MAXI N, H & L

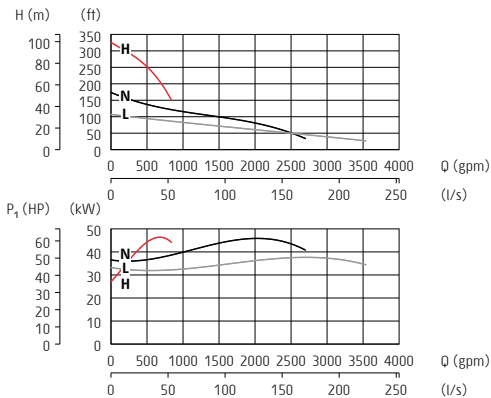
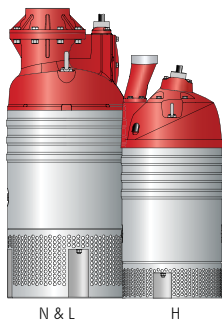

Technical Data 60 Hz	Maxi N	Maxi H*	Maxi L
Pump type	8107.011	8107.011	8107.030
Discharge connection	8"	4"	8"
Rated power P ₂	58 HP (43 kW)	58 HP (43 kW)	50 HP (37 kW)
Max. power cons. P ₁	48 kW	48 kW	42 kW
Shaft speed	3545 RPM	3545 RPM	1765 RPM
Rated current at 230V	136 A	136 A	120 A
Rated current at 460V	65 A *	65 A *	64 A *
Rated current at 575V	52 A *	52 A *	48 A *
Solids passage	0.6" (15 mm)	0.5" (12 mm)	0.6" (15 mm)
Max. height	51.3" (1302 mm)	41" (1046 mm)	51.3" (1302 mm)
Max. width	20" (506 mm)	17" (436 mm)	20" (506 mm)
Weight	618 lbs (280 kg)	530 lbs (240 kg)	628 lbs (285 kg)

* Also available in MSHA-approved design (curves and ratings may differ from above) - US only.
For further information, see data sheets. Specifications can be changed without notice.

MAXI SH

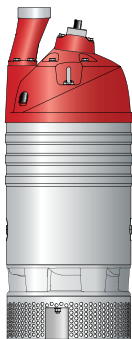
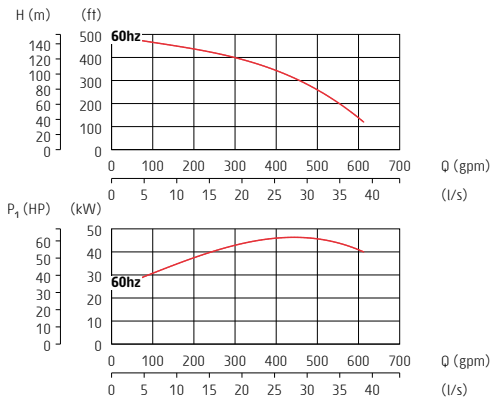

Technical Data 60 Hz

Maxi SH

Pump type	8107.011
Discharge connection	4"
Rated power P ₂	58 HP (43 kW)
Max. power cons. P ₁	48 kW
Shaft speed	3550 RPM
Rated current at 230V	133 A
Rated current at 460V	65 A
Rated current at 575V	52 A
Solids passage	0.5" (12 mm)
Max. height	45.2" (1148 mm)
Max. width	17.3" (440 mm)
Weight	595 lbs (270 kg)

For further information, see data sheets. Specifications can be changed without notice.

MAGNUM

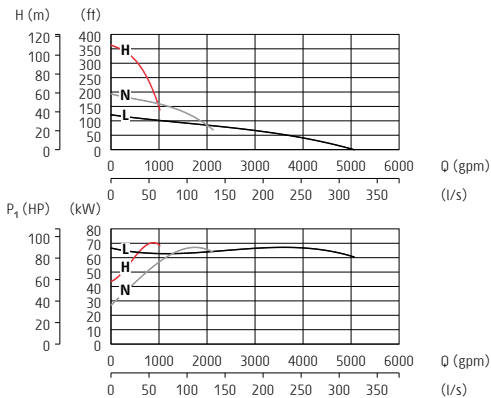
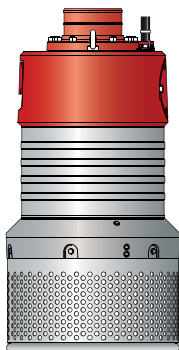

Technical Data 60 Hz	N	H	L
Pump type	8108.010	8108.010	8108.010
Discharge connection	8"	6"	10"
Rated power P2	90 HP (67 kW)	90 HP (67 kW)	90 HP (67 kW)
Max. power cons. P1	73 kW	75 kW	73 kW
Shaft speed	1770 RPM	3540 RPM	1770 RPM
Rated current at 230V	-	-	-
Rated current at 460V	107 A	101 A	107 A
Rated current at 575V	85 A	81 A	85 A
Solids passage	0.5" (12 mm)	0.5" (12 mm)	0.5" (12 mm)
Max. height	58" (1475 mm)	58" (1475 mm)	58" (1475 mm)
Max. width	29.5" (750 mm)	29.5" (750 mm)	29.5" (750 mm)
Weight	1190 lbs (540 kg)	1190 lbs (540 kg)	1190 lbs (540 kg)

For further information, see data sheets. Specifications can be changed without notice.

MEGA

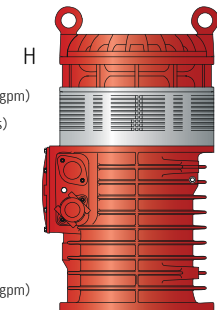
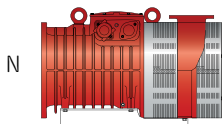
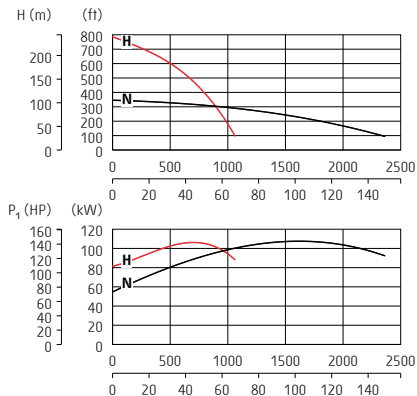

Technical Data 50 Hz	Mega N	Mega H
Pump type	8124.400	8124.400
Discharge connection	6" (DN150)	4" (DN100)
Rated power P ₂	140 HP (104 kW)	140 HP (104 kW)
Max. power cons. P ₁	110 kW	110 kW
Shaft speed	3560 RPM	3560 RPM
Rated current at 460V	148 A	148 A
Rated current at 575V	118 A	118 A
Solids passage	0.4" (10 mm)	0.4" (10 mm)
Max. height	30.3" (770 mm)	49" (1245 mm)
Diameter	24" (610 mm)	24" (610 mm)
Max. width	46.5" (1180 mm)	27.6" (700 mm)
Weight	1984 lbs (900 kg)	2172 lbs (985 kg)

For further information, see data sheets. Specifications can be changed without notice.

Materials in drainage pumps

	Micro	Milli	Mini	Minex	Minette	Minor	Major	Master	Matador	Maxi	Magnum	Mega
Material												
Inner seal												
Tungsten carbide - Tungsten carbide									•	•	•	•
Tungsten carbide - Aluminium oxide				•	•	•	•	•				
Carbon - Aluminium oxide	•	•	•									
Outer seal												
Tungsten carbide - Tungsten carbide										•	•	•
Silicon carbide - Silicon carbide	•	•	•	•	•	•	•	•	•			
Casted parts												
Aluminium	•	•	•	•	•	•	•	•	•	•	•	
Cast iron												•
Stator housing												
Aluminium	•	•	•	•	•	•	•	•	•	•	•	
Cast iron												•
Outer casing												
Stainless steel				•	•	•	•	•	•	•	•	
Aluminium	•	•	•									
Cast iron												•

For further information, see data sheets. Specifications can be changed without notice.

Materials in drainage pumps

	Micro	Milli	Mini	Minex	Minette	Minor	Major	Master	Matador	Maxi	Magnum	Mega
Material												
Motor shaft												
Stainless steel	•	•	•	•	•	•	•	•	•	•	•	•
Impeller												
Hard-Iron™				•	•	•	•	•	•	•	•	•
Polyurethane	•	•	•									
Suction cover												
Hard-Iron™					3~	•	•	•	•			
Lower diffuser												
Nitrile rubber										○		•
Polyurethane	•	•	•							•	•	○
Diffuser ring												
Nitrile rubber				•	•	•	•	•	•	○		•
Polyurethane	•	•	•			○	○	○	○	•	•	○
Screws and nuts												
Stainless steel	•	•	•	•	•	•	•	•	•	•	•	•
O-rings												
Nitrile rubber	•	•	•	•	•	•	•	•	•	•	•	•

For further information, see data sheets.
Specifications can be changed without notice.

• Standard ○ Option

Sludge pumps

Grindex sludge pumps are designed for professional use in tough applications like mines, construction sites, tunnel sites and other demanding industries.

They are designed for:

- Pumping water with high content of solids, up to the size of 80 mm.
- Pumping water which contains abrasive particles
- Pumping different types of mud and sludge
- Pumping light slurry

The pumps are designed for continuous, unattended operation. They have proven their reliability and dependable performance in demanding areas like building and construction, mining, tunnelling, quarries, industries, car washes and rental applications.



This page is a "target image" for the "Grindex Cutaway"-app with 3D and Augmented Reality functions

FEATURES

Sludge Pumps

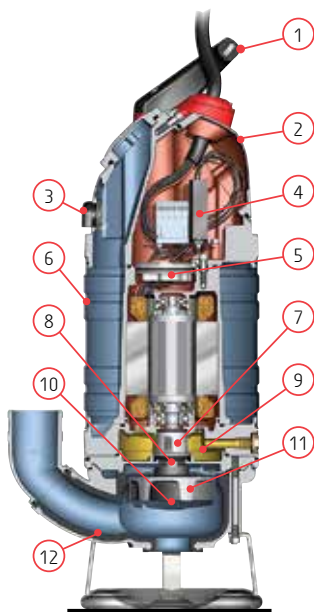

1. Ergonomic handle with a rubber grip on a metal frame
2. Inspection cover with large opening for easy access to junction box
3. Air valve cools the pump when no water is pumped
4. SMART motor protection including phase-failure guard, temperature guard and phase-sequence control eliminating the need for external start box
5. Enhanced terminal board with quick release terminal plate and sealing function
6. Durable outer jacket made from corrugated stainless steel
7. Easy service cartridge seal in rugged metal housing for improved heat transfer and longer pump life
8. Built-in particle repeller carries particles away from the seal for increased pump life
9. Simplified oil inspection and service, thanks to external plugs
10. Single adjustment screw for easy adjustment of the impeller and better performance
11. Hard-Iron™ impeller for maximum durability and performance
12. Heavy-duty polyurethane coating

SOLID

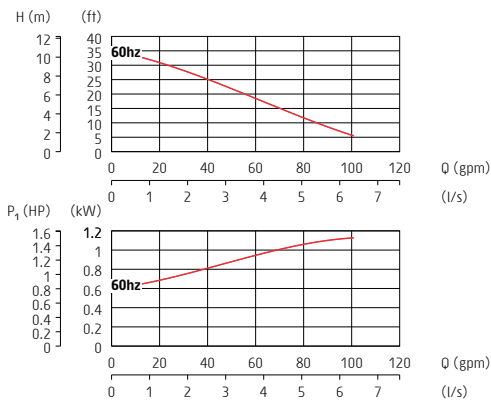

Technical Data 60 Hz

Solid

Pump type	8123.281
Discharge connection	2"
Rated power P ₂	1.1 HP (0.82 kW)
Max. power cons. P ₁	1.1 kW
Shaft speed	3400 RPM
Rated current at 115V	9.8 A
Rated current at 230V	4.8 A
Solids passage	1.5" (38 mm)
Max. height	20" (510 mm)
Max. width	10.4" (263 mm)
Weight	37.5 lbs (17 kg)

For further information, see data sheets. Specifications can be changed without notice.

SALVADOR

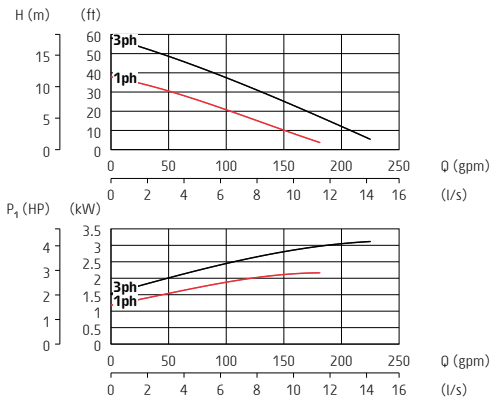

Technical Data 60 Hz

	Salvador 1-ph	Salvador 3-ph
Pump type	8109.282	8109.282
Discharge connection	3"	3"
Rated power P ₂	2.4 HP (1.8 kW)	3.5 HP (2.6 kW)
Max. power cons. P ₁	2.2 kW	3.1 kW
Shaft speed	3405 RPM	3410 RPM
Rated current at 230V	9.9 A	9.5 A
Rated current at 460V	-	4.7 A *
Rated current at 575V	-	3.5 A *
Solids passage	2" (50 mm)	2" (50 mm)
Max. height	30.8" (782 mm)	30.8" (782 mm)
Max. width	14" (354 mm)	14" (354 mm)
Weight	73 lbs (33 kg)	73 lbs (33 kg)

* Also available in MSHA-approved design (curves and ratings may differ from above) - US only.
For further information, see data sheets. Specifications can be changed without notice.

SENIOR

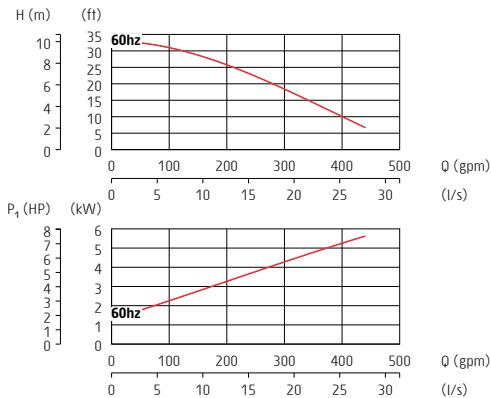

Technical Data 60 Hz

Senior N

Pump type	8110.281
Discharge connection	4"
Rated power P ₂	6.0 HP (4.5 kW)
Max. power cons. P ₁	5.7 kW
Shaft speed	1700 RPM
Rated current at 230V	17 A
Rated current at 460V	8.6 A
Rated current at 575V	6.9 A
Solids passage	3.2" (80 mm)
Max. height	34.1" (867 mm)
Max. width	18.9" (480 mm)
Weight	123 lbs (56 kg)

For further information, see data sheets. Specifications can be changed without notice.

SANDY

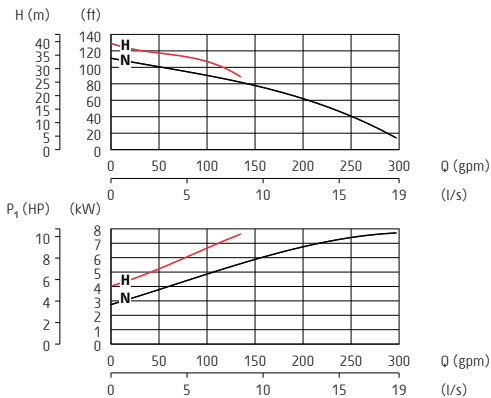

Technical Data 60 Hz

	Sandy N	Sandy H
Pump type	8111.281	8111.281
Discharge connection	3"	3"
Rated power P ₂	8.9 HP (6.6 kW)	8.9 HP (6.6 kW)
Max. power cons. P ₁	7.7 kW	7.7 kW
Shaft speed	3500 RPM	3500 RPM
Rated current at 230V	22 A	22 A
Rated current at 460V	11 A *	11 A *
Rated current at 575V	8.5 A *	8.5 A *
Solids passage	1.8" (46 mm)	1.3" (32 mm)
Max. height	34.1" (867 mm)	34.1 (867 mm)
Max. width	18.1" (460 mm)	16.9" (430 mm)
Weight	123 (56 kg)	123 (56 kg)

* Also available in MSHA-approved design (curves and ratings may differ from above) - US only.
For further information, see data sheets. Specifications can be changed without notice.

Materials in sludge pumps

	Solid	Salvador	Senior	Sandy
Material				
Inner seal				
Tungsten carbide - Aluminium oxide		•	•	•
Carbon - Aluminium oxide	•			
Outer seal				
Silicon carbide - Silicon carbide	•	•	•	•
Stator housing				
Aluminium	•	•	•	•
Outer casing				
Stainless steel		•	•	•
Aluminium	•			
Motor shaft				
Stainless steel	•	•	•	•

For further information, see data sheets. Specifications can be changed without notice.

Materials in sludge pumps

	Solid	Salvador	Senior	Sandy
Material				
Impeller				
Hard-Iron™		•	•	•
Polyurethane	•			
Pump housing				
Polyurethane	•			
Aluminium with polyurethane lining		•	•	•
Screws and nuts				
Stainless steel	•	•	•	•
O-rings				
Nitrile rubber	•	•	•	•
Casted parts				
Aluminium	•	•	•	•

For further information, see data sheets. Specifications can be changed without notice.

Drainage pumps made of stainless steel, INOX

These pumps are designed to meet the tough requirements from mines, construction sites, landfill sites and other applications that deal with corrosive water. One application is in mines where the water becomes caustic and destroys conventional pumps in matter of days. The pumps may also be used in applications where saltwater is pumped, like shipyards, fish farms, construction works in harbours and offshore projects. All INOX pumps can handle pH values from 2 - 10. They can also be equipped with zinc anodes for extra protection.

FEATURES

Inox Drainage Pumps

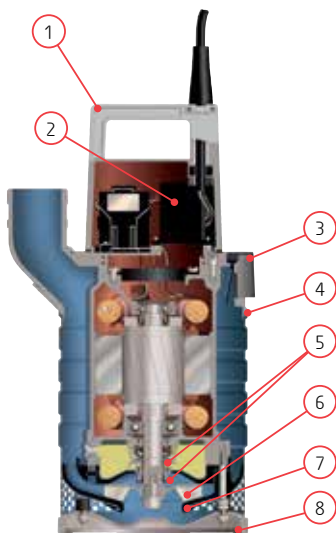

1. All steel parts are made of stainless steel
2. SMART motor protection including phase-failure guard, temperature guard, phase-sequence control and plug-&-play eliminating the need for external starter box
3. Air valve cools the pump when the pump is running dry
4. Durable outer casing made from corrugated stainless steel
5. Aquatite INOX - Double mechanical shaft seals with an oil compartment between the seals for longer pump life
6. Stainless steel impeller
7. Rubber lined adjustable diffusers to maintain optimum performance
8. Durable strainer in stainless steel with ergonomic grip

MINETTE INOX

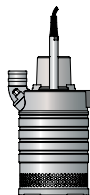
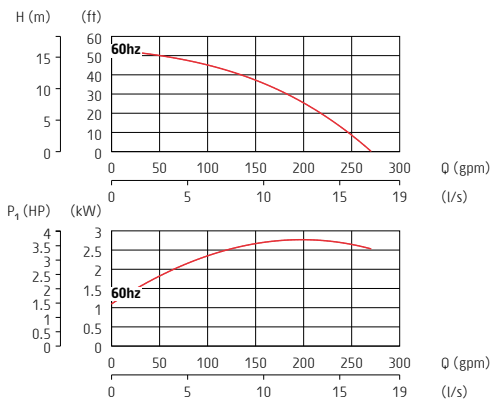

Technical Data 60 Hz

Minette Inox N

Pump type	8115.390
Discharge connection	3"
Rated power P ₂	3.1 HP (2.3 kW)
Max. power cons. P ₁	2.9 kW
Shaft speed	3315 RPM
Rated current at 230V	8.5 A
Rated current at 460V	4.2 A
Rated current at 575V	3.3 A
Solids passage	0.30" (7.5 mm)
Max. height	21" (535 mm)
Max. width	9.5" (240 mm)
Weight	97 lbs (44 kg)

For further information, see data sheets. Specifications can be changed without notice.

MAJOR INOX

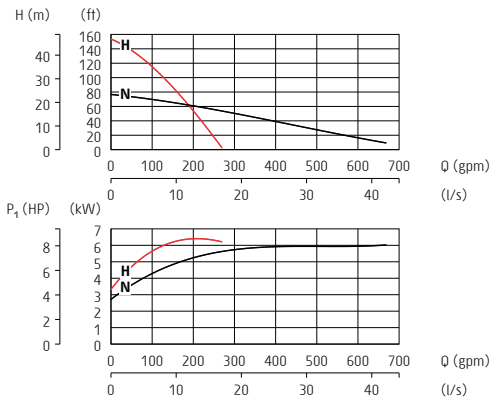
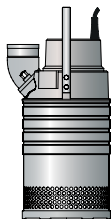

Technical Data 60 Hz

Major Inox N

Major Inox H

Pump type	8116.390	8116.390
Discharge connection	4"	3"
Rated power P ₂	9 HP (6.7 kW)	9 HP (6.7 kW)
Max. power cons. P ₁	7.6 kW	7.6 kW
Shaft speed	3455 RPM	3455 RPM
Rated current at 230V	21 A	21 A
Rated current at 460V	11 A	11 A
Rated current at 575V	8.6 A	8.6 A
Solids passage	0.35" (8.5 mm)	0.35" (8.5 mm)
Max. height	26.2" (665 mm)	26.2" (665 mm)
Max. width	13.1" (333 mm)	13.1" (333 mm)
Weight	144 lbs (65 kg)	144 lbs (65 kg)

For further information, see data sheets. Specifications can be changed without notice.

MASTER INOX

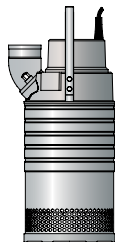
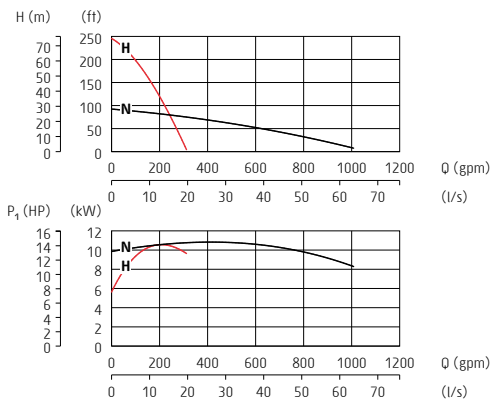

Technical Data 60 Hz

Master Inox N

Master Inox H

Pump type	8117.390	8117.390
Discharge connection	4"	3"
Rated power P ₂	13 HP (9.7 kW)	13 HP (9.7 kW)
Max. power cons. P ₁	11 kW	11 kW
Shaft speed	3455 RPM	3455 RPM
Rated current at 230V	30 A	30 A
Rated current at 460V	15 A	15 A
Rated current at 575V	12 A	12 A
Solids passage	0.35" (8.5 mm)	0.35" (8.5 mm)
Max. height	28.3" (720 mm)	28.3" (720 mm)
Max. width	13.1" (333 mm)	13.1" (333 mm)
Weight	171 lbs (77 kg)	180 lbs (81 kg)

For further information, see data sheets. Specifications can be changed without notice.

MEGA INOX

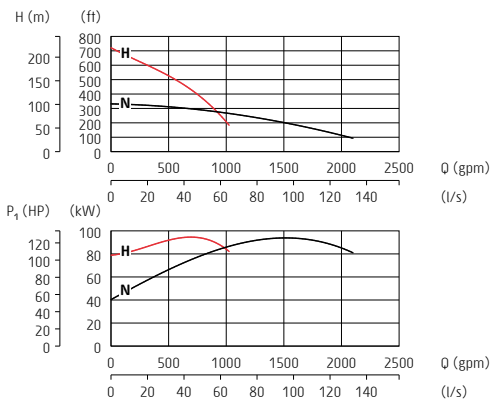
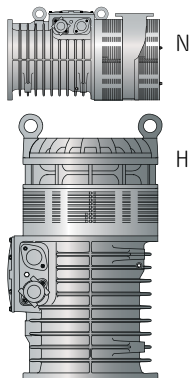

Technical Data 50 Hz

Mega Inox N

Mega Inox H

Pump type	8124.390	8124.390
Discharge connection	6" (DN150)	4" (DN100)
Rated power P ₂	127 HP (95 kW)	127 HP (95 kW)
Max. power cons. P ₁	100 kW	100 kW
Shaft speed	3560 RPM	3560 RPM
Rated current at 460V	135 A	135 A
Rated current at 575V	107 A	107 A
Solids passage	0.4" (10 mm)	0.4" (10 mm)
Max. height	30.3" (770 mm)	49.2" (1250 mm)
Diameter	24.4" (620 mm)	24.4" (620 mm)
Max. width	46.5" (1180 mm)	27.6" (700 mm)
Weight	2039 lbs (925 kg)	2238 lbs (1015 kg)

For further information, see data sheets. Specifications can be changed without notice.

Materials in drainage pumps made of stainless steel

	Minette INOX	Major INOX	Master INOX	Mega INOX
Material				
Inner seal				
Carbon - Silicon carbide	•	•	•	
Tungsten carbide - Tungsten carbide				•
Outer seal				
Silicon carbide - Silicon carbide	•	•	•	•
Casted parts				
Stainless steel (EN 10283-1.14412-ASTM CF-8M)	•	•	•	•
Outer casing				
Stainless steel (EN 10088-3-1.14436-AISI 316L)	•	•	•	•

*For further information, see data sheets.
Specifications can be changed without notice.*

Materials in drainage pumps made of stainless steel

Material	Minette INOX	Major INOX	Master INOX	Mega INOX
Motor shaft				
Stainless steel (EN 10088-3-1.14460-AISI 329)	•	•	•	•
Impeller				
Stainless steel (EN 10283-1.14412-ASTM CF-8M)	•	•	•	•
Screws and nuts				
Stainless steel (A4)	•	•	•	•
O-rings				
Viton rubber	•	•	•	•
Diffusers				
Nitrile rubber	•	•	•	•

*For further information, see data sheets.
Specifications can be changed without notice.*

Sludge pumps made of stainless steel, INOX

Our sludge pumps in stainless steel are used for pumping corrosive fluids with solids in harsh environment. The solids can be up to the size of 50 mm. These pumps are designed to meet the tough requirements from mines, construction sites, landfill sites and other applications that deal with corrosive water. One application is in mines where the water becomes caustic and destroys conventional pumps in matter of days. The pumps may also be used in applications where saltwater is pumped, like shipyards, fish farms, construction works in harbours and offshore projects. All INOX pumps can handle pH values from 2 - 10. They can also be equipped with zinc anodes for extra protection.

FEATURES

Inox Sludge Pumps

1. All steel parts are made of stainless steel
2. SMART motor protection including phase-failure guard, temperature guard, phase-sequence control and plug-&-play eliminating the need for external starter box
3. Air valve cools the pump when the pump is running dry
4. Durable outer casing made from corrugated stainless steel
5. Aquatite INOX - Double mechanical shaft seals with an oil compartment between the seals for longer pump life
6. Stainless steel impeller
7. Highly abrasive- and oil-resistant rubber lined pump housing

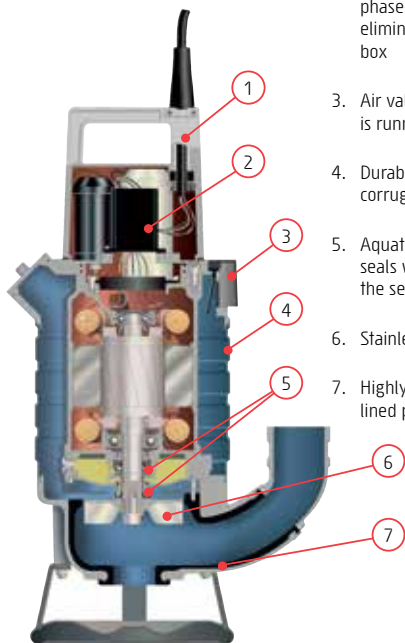

SALVADOR INOX

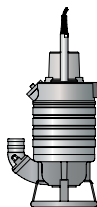
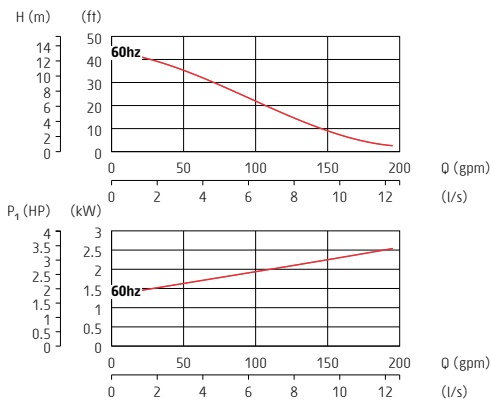

Technical Data 60 Hz

Salvador Inox

Pump type	8118.280
Discharge connection	3"
Rated power P ₂	3.1 HP (2.3 kW)
Max. power cons. P ₁	2.9 kW
Shaft speed	3320 RPM
Rated current at 230V	8.5 A
Rated current at 460V	4.2 A
Rated current at 575V	3.3 A
Solids passage	2" (50 mm)
Max. height	25.4" (645 mm)
Max. width	14.8" (375 mm)
Weight	104 lbs (47 kg)

For further information, see data sheets. Specifications can be changed without notice.

SENIOR INOX

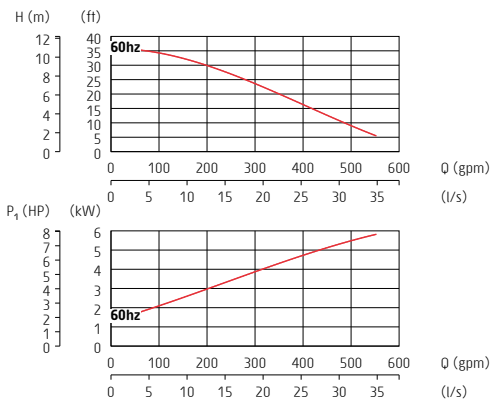
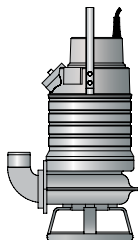

Technical Data 60 Hz

Senior Inox

Pump type	8119.280
Discharge connection	4"
Rated power P ₂	6.8 HP (5.1 kW)
Max. power cons. P ₁	6.2 kW
Shaft speed	1675 RPM
Rated current at 230V	18 A
Rated current at 460V	9 A
Rated current at 575V	7.3 A
Solids passage	3.2" (80 mm)
Max. height	29.7" (755 mm)
Max. width	19" (480 mm)
Weight	191 lbs (86 kg)

For further information, see data sheets. Specifications can be changed without notice.

SANDY INOX

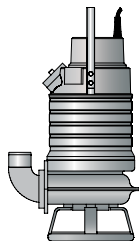
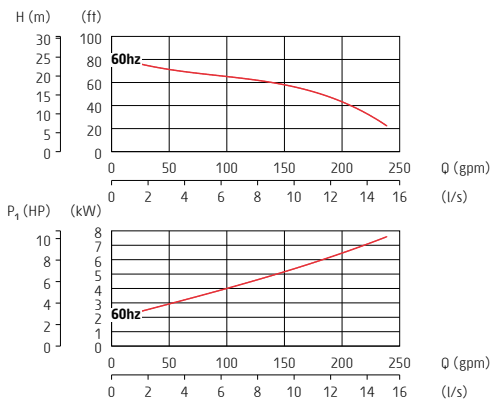

Technical Data 60 Hz

Sandy Inox

Pump type	8120.280
Discharge connection	3"
Rated power P ₂	9 HP (6.7 kW)
Max. power cons. P ₁	7.6 kW
Shaft speed	3455 RPM
Rated current at 230V	21 A
Rated current at 460V	11 A
Rated current at 575V	8.6 A
Solids passage	1.8" (46 mm)
Max. height	29.7" (755 mm)
Max. width	19" (480 mm)
Weight	191 lbs (86 kg)

For further information, see data sheets. Specifications can be changed without notice.

Materials in sludge pumps made of stainless steel

	Salvador INOX	Senior INOX	Sandy INOX
Material			
Inner seal			
Carbon - silicon carbide	•	•	•
Outer seal			
Silicon carbide - silicon carbide	•	•	•
Casted parts			
Stainless steel (EN 10283-1.14412-ASTM CF-8M)	•	•	•
Outer casing			
Stainless steel (EN 10088-3-1.14436-AISI 316L)	•	•	•
Motor shaft			
Stainless steel (EN 10088-3-1.14460-AISI 329)	•	•	•
Impeller			
Stainless steel (EN 10283-1.14412-ASTM CF-8M)	•	•	•
Screws and nuts			
Stainless steel (A4)	•	•	•
O-rings			
Viton rubber	•	•	•
Pump housing			
Nitrile rubber	•	•	•

*For further information, see data sheets.
Specifications can be changed without notice.*

Slurry pumps, BRAVO

Grindex slurry pumps are designed for use in quarries, mines, dredging, cleaning of settling ponds, other abrasive and other applications and industries that require pumps with very high durability. Each part of the BRAVO pump is designed for maximum endurance and reliability – an absolute must when pumping slurry. All BRAVO pumps can handle liquids with pH values from 5.5 up to 14.

The Bravo 400 to 900 are equipped with agitator beneath the pump intake to stir up settled material toward the pump intake. The Bravo 400 to 900 can also be fitted with an optional cooling jacket for use in dry pit applications.

Pumping slurry

Pumping fluids with high solids concentrations is more complicated than pumping water. To avoid sedimentation in the system you need to choose the right pump size and dimensions of hoses and pipes. The concentration of solids together with their size and shape may also affect pump performance and power requirements and therefore pump choice. Remember that settled solids might need external agitators, water jets or mixers to get them back in suspension and allow them to be pumped.

As each application requires its own calculation, we recommend you to contact your Grindex dealer for more information about slurry pumping.

FEATURES

Slurry Pumps

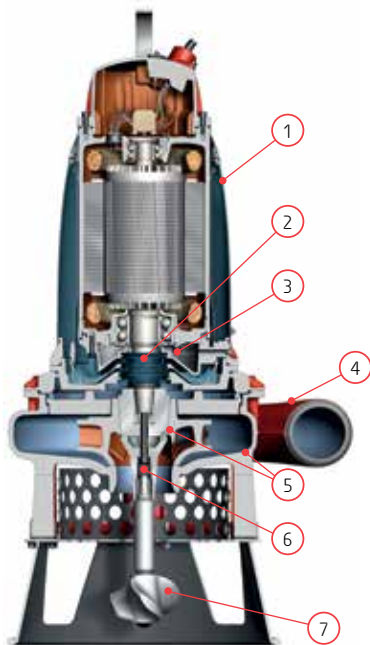

1. Optional cooling jacket for use in dry pit applications
2. Ready to install cartridge seal
3. Leakage sensor
4. Large throughlet handles solids of varying sizes
5. Hard-Iron™ impeller and pump housing for maximum durability and performance
6. Single adjustment sleeve unit for easy adjustment of the impeller
7. Agitator stirs up sand, sludge and solids in suspension

BRAVO 200

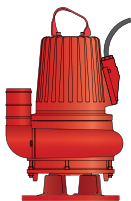
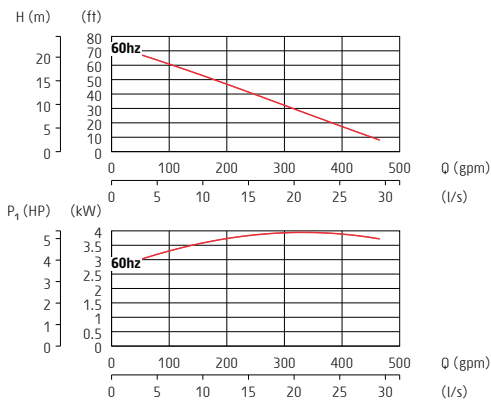

Technical Data 60 Hz

Bravo 200

Pump type	8146.020
Discharge connection	4"
Rated power P ₂	7.5 HP (5.6 kW)
Max. power cons. P ₁	6.7 kW
Shaft speed	1740 RPM
Rated current at 230V	19 A
Rated current at 460V	9.6 A
Rated current at 575V	7.8 A
Solids passage	2" (50 mm)
Max. height	29.9" (760 mm)
Max. width	18.1" (460 mm)
Weight	346 lbs (157 kg)

Also available in EX (Explosion Proof) version.

For further information, see data sheets. Specifications can be changed without notice.

BRAVO 300

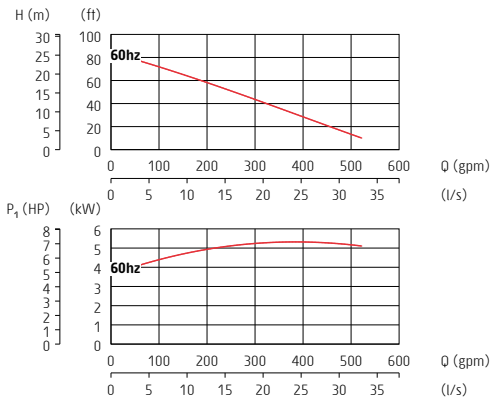
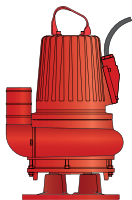

Technical Data 60 Hz

Bravo 300

Pump type	8147.020
Discharge connection	4"
Rated power P ₂	10 HP (7.5 kW)
Max. power cons. P ₁	8.9 kW
Shaft speed	1735 RPM
Rated current at 230V	25 A
Rated current at 460V	13 A
Rated current at 575V	10 A
Solids passage	2" (50 mm)
Max. height	29.9" (760 mm)
Max. width	18.1" (460 mm)
Weight	346 lbs (157 kg)

Also available in EX (Explosion Proof) version.

For further information, see data sheets. Specifications can be changed without notice.

BRAVO 400

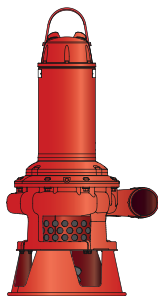
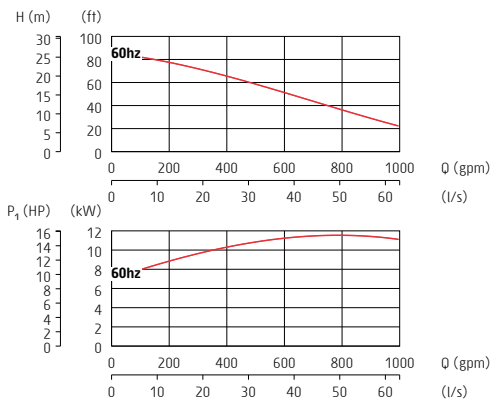

Technical Data 60 Hz

Bravo 400

Pump type	8148.020
Discharge connection	4"
Rated power P ₂	20.1 HP (15 kW)
Max. power cons. P ₁	17 kW
Shaft speed	1755 RPM
Rated current at 230V	52 A
Rated current at 460V	26 A
Rated current at 575V	21 A
Solids passage	1.2" (30 mm)
Max. height	45.2" (1148 mm)
Max. width	23.4" (595 mm)
Weight	509 lbs (231 kg)

Also available in EX (Explosion Proof) version.

For further information, see data sheets. Specifications can be changed without notice.

BRAVO 500

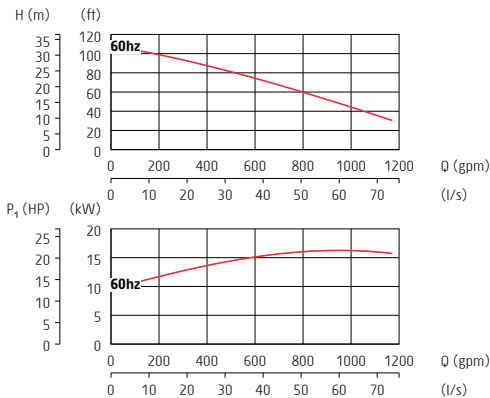
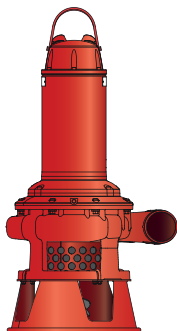

Technical Data 60 Hz

Bravo 500

Pump type	8149.020
Discharge connection	4"
Rated power P2	30 HP (22 kW)
Max. power cons. P1	25 kW
Shaft speed	1755 RPM
Rated current at 230V	75 A
Rated current at 460V	38 A
Rated current at 575V	29 A
Solids passage	1.6" (40 mm)
Max. height	50.1" (1273 mm)
Max. width	23.4" (595 mm)
Weight	646 lbs (293 kg)

Also available in EX (Explosion Proof) version.

For further information, see data sheets. Specifications can be changed without notice.

BRAVO 600

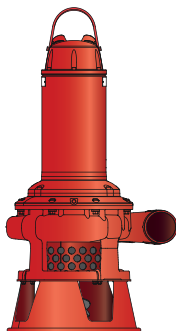
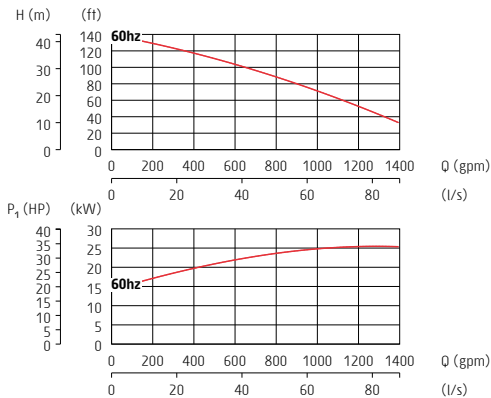

Technical Data 60 Hz

Bravo 600

Pump type	8150.020
Discharge connection	4"
Rated power P ₂	33.5 HP (25 kW)
Max. power cons. P ₁	28 kW
Shaft speed	1760 RPM
Rated current at 230V	81 A
Rated current at 460V	40 A
Rated current at 575V	32 A
Solids passage	1.6" (40 mm)
Max. height	50.1" (1273 mm)
Max. width	23.4" (595 mm)
Weight	646 lbs (293 kg)

Also available in EX (Explosion Proof) version.

For further information, see data sheets. Specifications can be changed without notice.

BRAVO 700

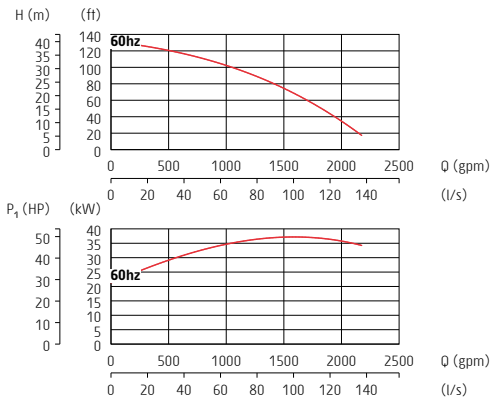
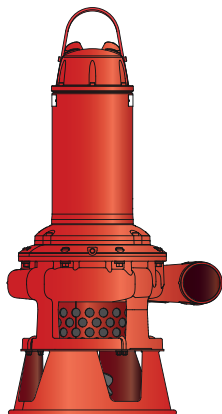

Technical Data 60 Hz

Bravo 700

Pump type	8151.020
Discharge connection	6"
Rated power P ₂	60.3 HP (45 kW)
Max. power cons. P ₁	49 kW
Shaft speed	1775 RPM
Rated current at 230V	-
Rated current at 460V	69 A
Rated current at 575V	55 A
Solids passage	1.4" (36 mm)
Max. height	65" (1652 mm)
Max. width	34.5" (875 mm)
Weight	1351 lbs (613 kg)

Also available in EX (Explosion Proof) version.

For further information, see data sheets. Specifications can be changed without notice.

BRAVO 800

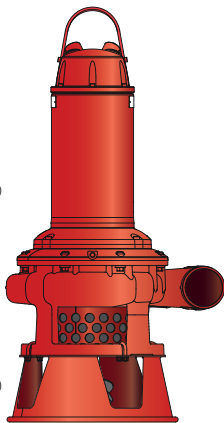
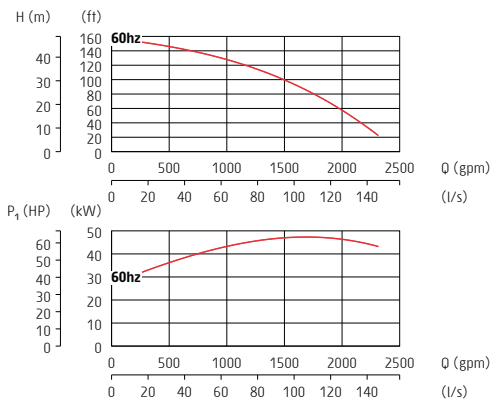

Technical Data 60 Hz

Bravo 800

Pump type	8152.020
Discharge connection	6"
Rated power P ₂	79.7 HP (52 kW)
Max. power cons. P ₁	56 kW
Shaft speed	1775 RPM
Rated current at 230V	-
Rated current at 460V	80 A
Rated current at 575V	63 A
Solids passage	1.4" (36 mm)
Max. height	65" (1652 mm)
Max. width	34.5" (875 mm)
Weight	1351 lbs (613 kg)

Also available in EX (Explosion Proof) version.

For further information, see data sheets. Specifications can be changed without notice.

BRAVO 900

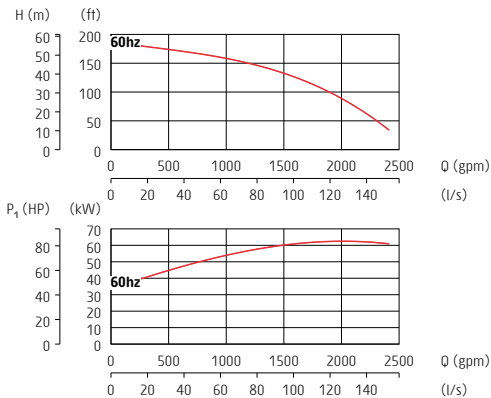
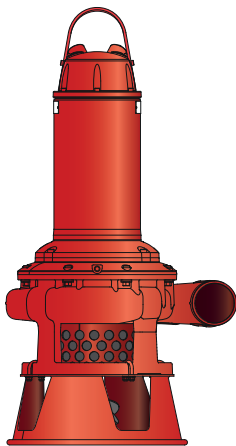

Technical Data 60 Hz

Bravo 900

Pump type	8153.020
Discharge connection	6"
Rated power P2	104.5 HP (78 kW)
Max. power cons. P1	84 kW
Shaft speed	1775 RPM
Rated current at 230V	-
Rated current at 460V	125 A
Rated current at 575V	101 A
Solids passage	1.4" (36 mm)
Max. height	70" (1779 mm)
Max. width	34.5" (875 mm)
Weight	1863 lbs (845 kg)

Also available in EX (Explosion Proof) version.

For further information, see data sheets. Specifications can be changed without notice.

Materials in slurry pumps

	Bravo 200	Bravo 300	Bravo 400	Bravo 500	Bravo 600	Bravo 700	Bravo 800	Bravo 900
Material								
Inner seal								
Tungsten carbide - Aluminium oxide	•	•						
Tungsten carbide - tungsten carbide			•	•	•	•	•	•
Outer seal								
Tungsten carbide - tungsten carbide	•	•	•	•	•	•	•	•
Drive unit								
Cast iron	•	•	•	•	•	•	•	•
Suction cover								
Nitrile rubber	•	•	-	-	-	-	-	-
Pumphousing								
Cast iron	•	•	-	-	-	-	-	-
Hard-Iron™	-	-	•	•	•	•	•	•
Discharge connection type								
Thread or hose connection	•	•	-	-	-	-	-	-
Victualic connection	-	-	○	○	○	○	○	○

For further information, see data sheets.
Specifications can be changed without notice.

• Standard ○ Option - Not available

Materials in slurry pumps

	Bravo 200	Bravo 300	Bravo 400	Bravo 500	Bravo 600	Bravo 700	Bravo 800	Bravo 900
Material								
Agitator								
Hard-Iron™	-	-	•	•	•	•	•	•
Impeller								
Hard-Iron™	•	•	•	•	•	•	•	•
Lifting handle								
Galvanised steel	•	•	-	-	-	-	-	-
Stainless steel	-	-	•	•	•	•	•	•
Motor shaft								
Stainless steel	•	•	•	•	•	•	•	•
Studs, screws and nuts								
Stainless steel	•	•	•	•	•	•	•	•

For further information, see data sheets.
Specifications can be changed without notice.

• Standard ◦ Option - Not available

Primo pumps

Grindex Primo is a range of small, handy and affordable pumps, including two drainage and two sludge pumps. The Primo pumps are ideal for construction, industrial and municipal jobs, and the highly compact design allows the Primo pumps to operate in dewatering applications where others don't fit.

PRIMO D4

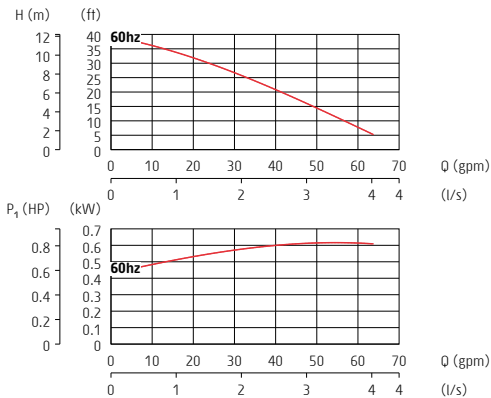

Technical Data 60 Hz

Primo D4

Pump type	5182310 (230V) / 5182410 (115V)
Discharge connection	2"
Rated power P2	0.5 HP (0.4 kW)
Max. power cons. P1	0.67 kW
Shaft speed	3400 RPM
Rated current at 115V	5.8 A
Rated current at 230V	3.2 A
Solids passage	0.3" (7.5 mm)
Max. height	13.4" (340 mm)
Max. width	7.2" (183 mm)
Weight	20 lbs (9 kg)

For further information, see data sheets. Specifications can be changed without notice.

PRIMO D8

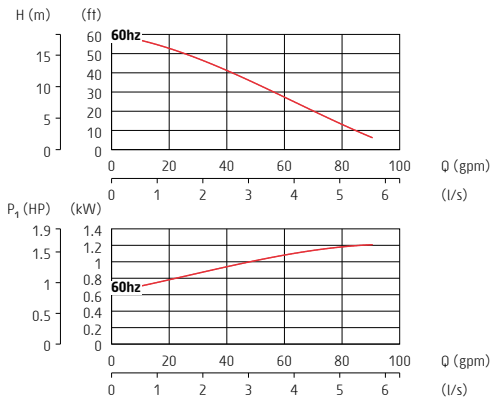

Technical Data 60 Hz

Primo D8

Pump type	5182330 (230V) / 5182430 (115V)
Discharge connection	2"
Rated power P ₂	1.0 HP (0.75 kW)
Max. power cons. P ₁	1.19 kW
Shaft speed	3400 RPM
Rated current at 115V	10.3 A
Rated current at 230V	5.1 A
Solids passage	0.3" (7.5 mm)
Max. height	15.1" (384 mm)
Max. width	7.2" (183 mm)
Weight	29 lbs (13 kg)

For further information, see data sheets. Specifications can be changed without notice.

PRIMO S4

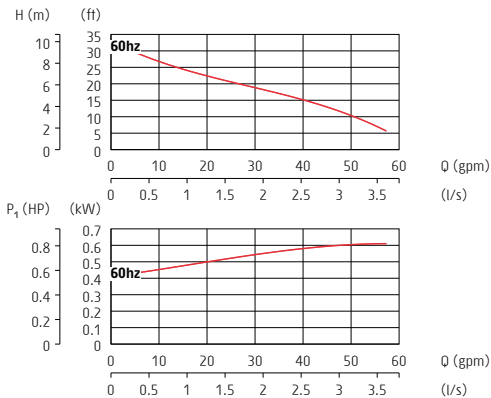
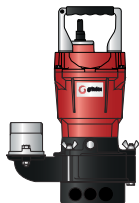

Technical Data 60 Hz

Primo S4

Pump type	5182320 (230V) / 5182420 (115V)
Discharge connection	2"
Rated power P2	0.5 HP (0.4 kW)
Max. power cons. P1	0.67 kW
Shaft speed	3400 RPM
Rated current at 115V	5.8 A
Rated current at 230V	3.2 A
Solids passage	1" (25 mm)
Max. height	14.7" (373 mm)
Max. width	9.5" (241 mm)
Weight	22 lbs (10 kg)

For further information, see data sheets. Specifications can be changed without notice.

PRIMO S8

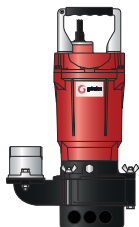
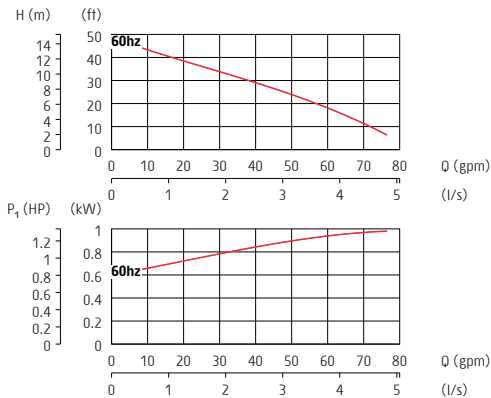

Technical Data 60 Hz

Primo S8

Pump type	5182340 (230V) / 5182440 (115V)
Discharge connection	2"
Rated power P ₂	1.0 HP (0.75 kW)
Max. power cons. P ₁	1.19 kW
Shaft speed	3400 RPM
Rated current at 115V	10.3 A
Rated current at 230V	5.1 A
Solids passage	1" (25 mm)
Max. height	16.4" (416 mm)
Max. width	9.5" (241 mm)
Weight	29 lbs (13 kg)

For further information, see data sheets. Specifications can be changed without notice.

Materials in Primo pumps

	Primo D4	Primo D8	Primo S4	Primo S8
Material				
Inner seal				
Silicon carbide - Silicon carbide	•	•	•	•
Outer seal				
Silicon carbide - Silicon carbide	•	•	•	•
Pump top				
Aluminium	•	•	•	•
Outer casing				
Steel	•	•	-	-
Stator housing				
Aluminium	•	•	•	•
Motor shaft				
Stainless steel	•	•	•	•
Impeller				
Cast iron	-	-	•	•
Polyurethane	•	•	-	-
Diffuser				
Cast iron	•	•	•	•
Screws and nuts				
Stainless steel	•	•	•	•

*For further information, see data sheets.
Specifications can be changed without notice.*

Accessories

Some applications require the use of additional devices. Here is a list of Grindex accessories and what pump they can be used with.

- Available
- Not an optimal choice
- x Not available
- Together with external starter
- () Letter in parentheses refer to pump model

	Zinc anodes	Low suction collar	Float switch	Tandem connection	Pump raft
Drainage pumps					
Micro	X	●	●	X	●
Milli	X	X	○	X	○
Mini	X	●	●	X	●
Minex	●	●	●	X	●
Minette	●	●	●	X	●
Minor	●	●	●	●	●
Major	●	●	●	●	●
Master	●	X	●	●	●
Matador	●	X	●	●	●
Maxi	●	X	□	●	●
Magnum	●	X	□	● (H)	●
Mega	●	X	□	X	●
Sludge pumps					
Solid	X	X	●	X	○
Salvador	●	X	●	X	○
Senior	●	X	●	X	○
Sandy	●	X	●	X	○

For further information, see data sheets. Specifications can be changed without notice.

Accessories

	Zinc anodes	Low suction collar	Float switch	Tandem connection	Pump raft
Drainage pumps made of stainless steel					
Minette Inox	●	●	□	X	○
Major Inox	●	●	□	X	○
Master Inox	●	●	□	X	○
Mega Inox	●	X	□	X	●
Sludge pumps made of stainless steel					
Salvador Inox	●	X	□	X	○
Senior Inox	●	X	□	X	○
Sandy Inox	●	X	□	X	○
Slurry pumps					
Bravo 200	●	X	□	X	●
Bravo 300	●	X	□	X	●
Bravo 400	●	X	□	X	●
Bravo 500	●	X	□	X	●
Bravo 600	●	X	□	X	●
Bravo 700	●	X	□	X	●
Bravo 800	●	X	□	X	●
Bravo 900	●	X	□	X	●
Primo pumps					
Primo D4	X	X	●*	X	●
Primo D8	X	X	●*	X	●
Primo S4	X	X	●*	X	●
Primo S8	X	X	●*	X	●

* Limited availability, please check with your local dealer.

For further information, see data sheets. Specifications can be changed without notice.

Grindex Pump School

The school consists of technical articles, intended to help pump users with common matters in pumping with submersible pumps.

Part 1: Choosing the right pump type for the job

A drainage pump is the most commonly used pump type at construction sites. It is used for pumping water with less abrasive solids, like clay. Sand and solids in suspension can also be pumped, up to the size of the strainer holes (normally 0.3-0.5" or 7-12 mm). As sand is quite abrasive to the pump, it must not be too concentrated.



Sludge pumps are suitable for pumping water with solids, as well as for pumping sludge. The solids can be up to the size of the pump inlet diameter (normally 1.3-3.1" or 32-80 mm).



Pumps made of stainless steel are often used in copper mines, gold mines and other applications with corrosive fluids. An aluminium pump can handle water with pH values from 5-8, while a stainless steel pump can cope with pH values from 2-10.



Slurry pumps are designed to handle abrasive solids in suspension, like sand, gravel and concrete, in high concentration. They are also frequently used to move sand in suspension, i.e. at a dredging operation. To cope with the abrasives, the hydraulic parts of a slurry pump are often made of a very hard metal alloy. For improved performance, bigger slurry pumps can be equipped with agitator.



Plug and pump

An electrical submersible pump is easy to use, just plug it in and pump. Several small pumps, placed where the need is for the moment, can pump the water to a dedicated collecting pit through long hoses. As the smaller pumps only weights 22-55 lbs (10-25 kg), you can carry the pump with you as the works moves to different spots at the site.



In the collection pit, a bigger pump is installed and pumps the water away from the site. By connecting hoses from several pumps to the pit, you can easily dewater a large area with just a few pumps.



Part 2: Pump arrangement

Despite the simplicity, there are a few details to consider for optimizing the pumping:

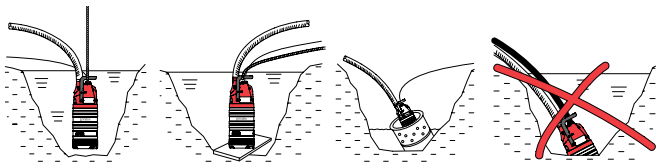

Arrange the pump so it doesn't burrow itself into sand or clay. This is a common problem at construction sites. It can be avoided quite simple by placing the pump on a bed of coarse gravel or a plank. The pump can also be hung freely by a rope or chain, or put into a cut-down and perforated oil drum.

Avoid sharp bend on the hose

As sharp bends, kinks and pinching of the hose are reducing the capacity of the pump, a lot is won by avoiding those circumstances. Turning the pumps discharge connection so the hose doesn't begin with at kink is easily arranged; it can be fitted vertical or horizontal on almost all Grindex pumps.

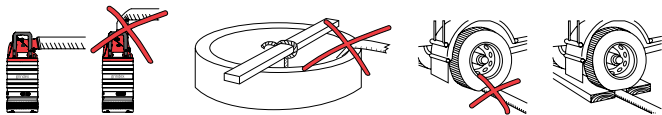

Tandem connection

In order to achieve higher pumping heads, two or more drainage pumps can be connected in series. For this purpose, a series connecting flange is available as an accessory. It is important that the hoses are equipped with check valves, preventing the pumps from suffering from wear when the water runs back from high heads uncontrolled if a power failure should occur.

Long distance pumping

Tandem connection of pumps can also be used when the water needs to be pumped a longer distance. A simple arrangement can be pumping the water to a dedicated collection pit. The pit should be equipped with another pump, passing the water on. This technique can also be used for dewatering a greater area with several pumps spread out, pumping the water to a collection pit. The pit is then equipped with a greater pump, that pumps the water away from the site.

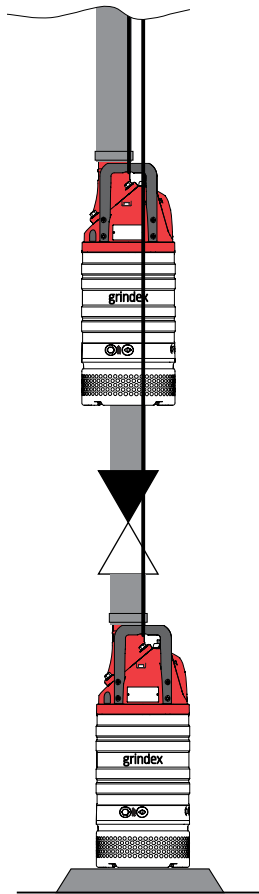

Part 3: Sedimentation

The pumped water is often containing solids that cause wear to pumps, valves and other dewatering equipment. This problem is very common in mines and tunnel construction sites. When pumping water that contains solids (like drill cuttings and sand), there is a risk of sedimentation in the system. A typical symptom is pipes and/or hoses that get filled with sediment, resulting in capacity losses. When the amount of solids increases, there is also an increase of wear on the pump.

One way to prevent this is by using sedimentation tanks where the drill cuttings may settle while the rest of the water is pumped away. The tank needs to be as close to the source as possible, ensuring that the solids are pumped as short distance as possible where the solids can settle in peace. To ensure the efficiency of the sedimentation tank, it needs to have as big surface area as possible. The more solids present in the water, the more care should be taken in the design of the sedimentation system.

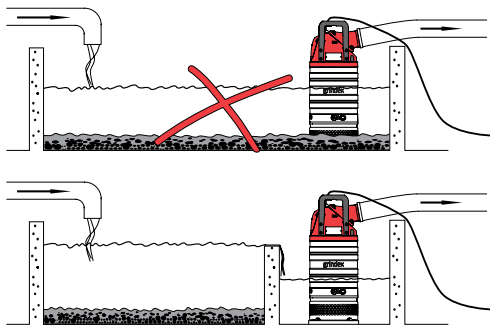

For applications where solids can not be avoided, there are recommendations for the velocity of the medium in the discharge line:

Mixture	Min. velocity in discharge line
1. Water + coarse gravel	13.1ft/s (4 m/s)
2. Water + gravel	11.5 ft/s (3 m/s)
3. Water + sand	
Sand particles < 0.1 mm (0.004 in)	8.2 ft/s (1.5 m/s)
Sand particles < 0.6 mm (0.024 in)	4.9 ft/s (2.5 m/s)



Limitations for Grindex pumps

Limitations	Drainage pumps	Sludge pumps
Max. submersion depth (IP68)	66 ft (20 m), except: Micro, Milli & Mini: 33 ft (10 m) Mega: 246 ft (75 m)	66 ft (20 m), except: Solid: 33 ft (10 m)
Max. liquid temperature <i>Option: 70°C version*</i>	104°F (40°C) 158°F (70°C)	104°F (40°C) -
Max. liquid density	68 lbs/ft ³ (1100 kg/m ³)	68 lbs/ft ³ (1100 kg/m ³)
pH of the liquid	5-8 (except Mega: 6-13)	5-8

Limitations	Stainless steel pumps	Slurry pumps
Max. submersion depth (IP68)	66 ft (20 m)	66 ft (20 m)
Max. liquid temperature	104°F (40°C)	104°F (40°C)
Max. liquid density	68 lbs/ft ³ (1100 kg/m ³)	80-106 lbs/ft ³ (1300-1700 kg/m ³)
pH of the liquid	2-10	5.5 - 14

* Option: 70°C version - Drainage pumps:

Minex, Minette, Minor, Major, Master & Matador

Chart for calculating friction losses in hoses

All pump capacities are measured for clean water, directly at the discharge outlet. When connecting a hose you need to consider the friction losses that come from the size and length of the hose. The chart below shows this.

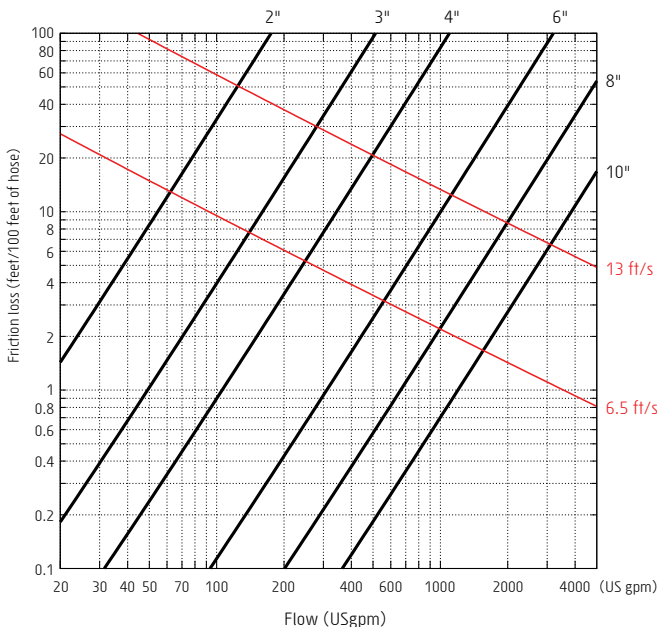

Formulas for calculating friction losses in hoses and tubes

The chart on page 73 was created using the following formulas:

Friction loss (meters)	Velocity (m/s)	Reynolds number	Friction factor (Swamee & Jain formula)
$\frac{H_{friction}}{1000} = \frac{f \times L \times v^2}{2 \times g \times D}$	$V = \frac{Q}{D^2}$	$Re = \frac{v \times D}{\mu}$	$f = \frac{0.25}{\left[\log \left(\frac{\epsilon}{3.7 \times D} + \frac{5.74}{Re^{0.9}} \right) \right]^2}$
f = friction factor L = length (m) v = avg. velocity g = 9.81 m/s ² D = pipe Ø (mm)	Q = flow (l/s) D = pipe Ø (mm)	v = velocity D = pipe Ø (mm) μ = viscosity = 1.161 x 10 ⁻⁶ m ² /s = 1 cSt	ε = roughness factor (mm) D = pipe Ø (mm) Re = Reynolds number

Friction factor

Material	Cast iron	Stainless	PVC	HDPE	Concrete	Hose
ε new (mm)	0.25	0.10	0.05	0.05	0.50	0.25
ε used (mm)	1.00	0.25	0.25	0.25	3.00	1.00

Sludge/slurry solids concentration

By volume (C _v)	By mass/weight (C _m)	Mixture
$C_v = \frac{V_{solids}}{V_{solids+water}}$	$C_m = \frac{m_{solids}}{m_{solids+water}}$	$\frac{SV_{mixture}}{SV_{solids}} = \frac{C_v}{C_m}$
V_{solids} = volume of solids V_{solids+water} = total sludge volume	m_{solids} = mass of solids m_{solids+water} = total sludge mass	SV = Specific weight

pH tables

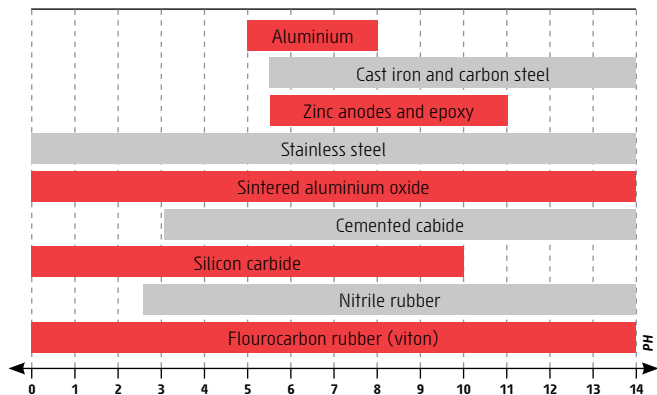

Salt tables

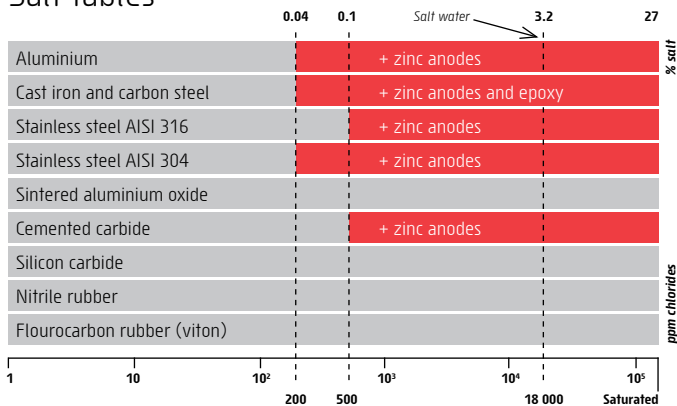

Translation charts

Pressure

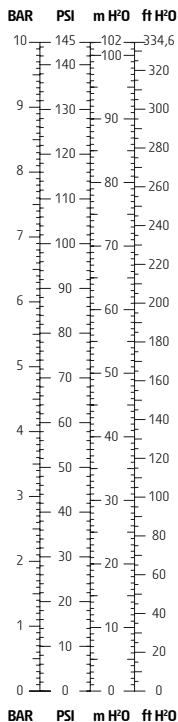

Effect

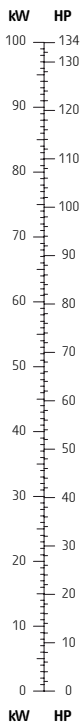

Flow

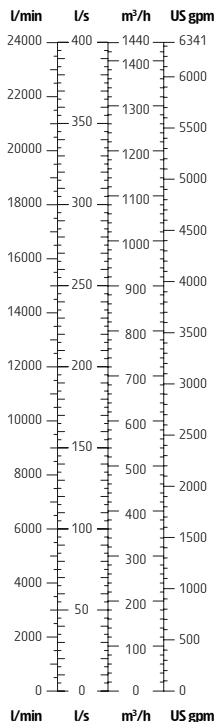

Temperature

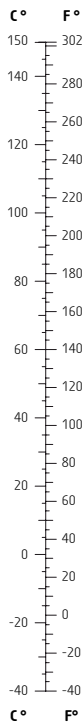

Recommended generator sizes

Voltages 3~460 V, 60 Hz

Pump model	Max. power consumption	Rated current	Permissible cable length**	Delayed fuse	Generator set
Minex	1.8 kW	2.6 A	980 ft	10 A	5 kVA
Minette	3.1 kW	4.7 A	650 ft	10 A	8 kVA
Minor N H	5.2 kW	7.1 A	490 ft	20 A	15 kVA
Major N H	7.7 kW	11.0 A	490 ft	20 A	20 kVA
Master N H SH	12.8 kW	18.0 A	490 ft	30 A	35*/40 kVA
Matador N H	22.0 kW	31.0 A	290 ft	50 A	60*/70 kVA
Maxi H Lite	32.0 kW	44.0 A	360 ft	63 A	55*/70 kVA
Maxi N H	48.0 kW	65.0 A	360 ft	100 A	120*/150 kVA
Maxi L	42.0 kW	64.0 A	390 ft	100 A	110*/130 kVA
Magnum	75.0 kW	107 A	360 ft	125 A	200*/250 kVA
Mega	110 kW	148 A	520 ft	170 A	275*/350 kVA
Minette Inox	2.9 kW	4.2 A	820 ft	10 A	8 kVA
Major Inox	7.6 kW	11 A	490 ft	20 A	20 kVA
Master Inox	11.0 kW	15 A	590 ft	20 A	30 kVA
Salvador	3.1 kW	4.7 A	980 ft	10 A	8 kVA
Senior	5.7 kW	8.6 A	650 ft	20 A	15 kVA
Sandy	7.7 kW	11.0 A	490 ft	20 A	20 kVA
Salvador Inox	2.9 kW	4.2 A	820 ft	10 A	8 kVA
Senior Inox	6.2 kW	9.0 A	650 ft	20 A	16 kVA
Sandy Inox	7.6 kW	11 A	490 ft	20 A	20 kVA

*Y/D start **Valid for standard cable sizes

Recommended generator sizes

Voltages 1~230 V, 60 Hz

Pump model	Max. power consumption	Rated current	Permissible cable length*	Delayed fuse	Generator set
Micro/Milli	0.65 kW	2.9 A	160 ft	10 A	3 KVA
Mini	1.1 kW	4.8 A	160 ft	10 A	4 KVA
Minex Lite	1.3 kW	5.6 A	230 ft	10 A	4 KVA
Minex	1.8 kW	8.2 A	160 ft	20 A	5 KVA
Minette	2.2 kW	9.9 A	230 ft	20 A	6 KVA
Solid	1.1 kW	4.8 A	160 ft	10 A	4 KVA
Salvador	2.2 kW	9.9 A	230 ft	20 A	6 KVA

**Valid for standard cable sizes*

Note

- In general, delayed fuse shall be dimensioned by rated current x 1.75
- The above given kVA values are meant as guidelines to simplify the choice of generator size.

Regarding size of generator set, each different type has different characteristic; therefore it is always recommended to consult the manufacturer of generator to find out if the actual generator is capable of operating the pump.

Make sure that the cable is sized to allow a voltage drop of max. 5% of the nominal voltage.

Bolt Tightening Torque values

All screws and nuts must be lubricated to achieve correct tightening torque. Screws that are screwed into stainless steel must have the threads coated with suitable lubricants to prevent seizing.

Table 1: Stainless steel, A2 and A4, torque Nm (ft-lbs): Screws and nuts

Property class	M4	M5	M6	M8	M10	M12	M16	M20	M24	M30
50	1.0 (0.74)	2.0 (1.5)	3.0 (2.2)	8.0 (5.9)	15 (11)	27 (20)	65 (48)	127 (93.7)	220 (162)	434 (320)
70, 80	2.7 (2)	5.4 (4)	9.0 (6.6)	22 (16)	44 (32)	76 (56)	187 (138)	364 (268)	629 (464)	1240 (915)
100	4.1 (3)	8.1 (6)	14 (10)	34 (25)	66 (49)	115 (84.8)	248 (183)	481 (355)	-	-

Table 2: Steel, torque Nm (ft-lbs): Screws and nuts.

Property class	M4	M5	M6	M8	M10	M12	M16	M20	M24	M30
8.8	2.9 (2.1)	5.7 (4.2)	9.8 (7.2)	24 (18)	47 (35)	81 (60)	194 (143)	385 (285)	665 (490)	1310 (966)
10.9	4.0 (2.9)	8.1 (6)	14 (10)	33 (24)	65 (48)	114 (84)	277 (204)	541 (399)	935 (689)	1840 (1357)
12.9	4.9 (3.6)	9.7 (7.2)	17 (13)	40 (30)	79 (58)	136 (100)	333 (245)	649 (480)	1120 (825)	2210 (1630)

Hexagon screws with countersunk heads

For hexagon socket head screws with countersunk head, maximum torque for all property classes must be 80% of the values for property class 8.8 above.



See “Grindex Cutaway”, our Augmented Reality interactive 3D app for looking inside a Grindex submersible drainage pump.

Get the app at App Store or Play Store, and use the target image on page 5 in this handbook to see the 3D pump. It’s free of course.



Grindex Pumps

8402 W. 183rd Street Suite A
Tinley Park, Illinois 60487 USA
Phone: +1 708-781-2135
Website: www.grindex.com